



*Now  
with  
Doors!*



**TARGA**

**Maximize your security, protection  
and energy efficiency**





**TARGA**

# The Attractive Vinyl Window and Door

**Keeping the elements out  
and the savings in.**



TARGA is an Old English word for shield. Today, energy-efficient impact-resistant vinyl windows and doors like the line from CGI – aptly named Targa – act as shields to safeguard your home and family with strength, security and style.

As the premier manufacturer of impact windows and doors, CGI products offer superior strength, quality and beauty. Our newest addition Targa is no different. Targa windows and doors will enhance the aesthetics of your home while providing you products with low maintenance, long term durability, and environmental compatibility.



The Targa line was designed specifically to exceed the Florida Impact codes, the most stringent impact standards in the U.S.

Contact a Targa dealer today to learn more and see why an investment in Targa windows and doors by CGI is an exceptional value.



# The TARGA Vinyl Advantage

## Glass Thickness

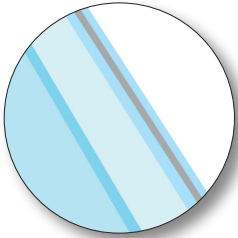

**THEIRS**  
Typically uses 7/8" insulated laminated glass

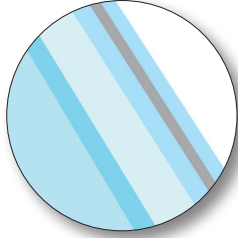

**TARGA**  
Available with 1" insulated laminated glass for better energy efficiency

## Triple Weatherstripping



**THEIRS**  
Two rows of weatherstripping

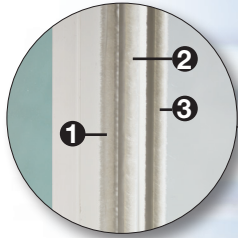

**TARGA**  
Triple weatherstripping at the jamb creates superior energy efficient air and water infiltration protection

## Trim



**THEIRS**  
Basic trim



**TARGA**  
Contoured trim for an added touch of elegance





**Glass Options**



**TARGA**  
Available in monolithic laminated glass and insulated laminated glass

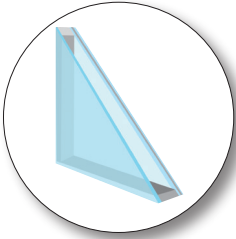

**THEIRS**  
Available with insulated laminated glass

**Tilt Latches**



**TARGA**  
Recessed latches for optimal function and form



**THEIRS**  
Bulky protruding latches

**Balances Comparison**



**TARGA**  
Lift Assist Constant Force Balance System on most sizes for prolonged durability and ease of operation



**THEIRS**  
Spiral balance system

## The Material Matters: Why Vinyl?

**Most commonly used window framing material in the U.S.**

- ▶ Enhanced energy efficiency
- ▶ Strength and durability
- ▶ Low maintenance costs
- ▶ Sustainability



**Why is Targa better? Pharmaceutical grade vinyl. It's what we're made of.**



**We did our homework and selected the very best formulation**

- ▶ Material sciences program with over 75 years of experience
- ▶ Has been used in over 50 million windows
- ▶ Improved impact resistance and enhanced color retention
- ▶ Undergoes uncompromising quality and performance testing
- ▶ Utilizes 100% plant based materials for all lubricants

**Long lasting. Low maintenance. Top insulating properties.  
High energy efficiency ratings. Low lifecycle costs. Sustainability!**

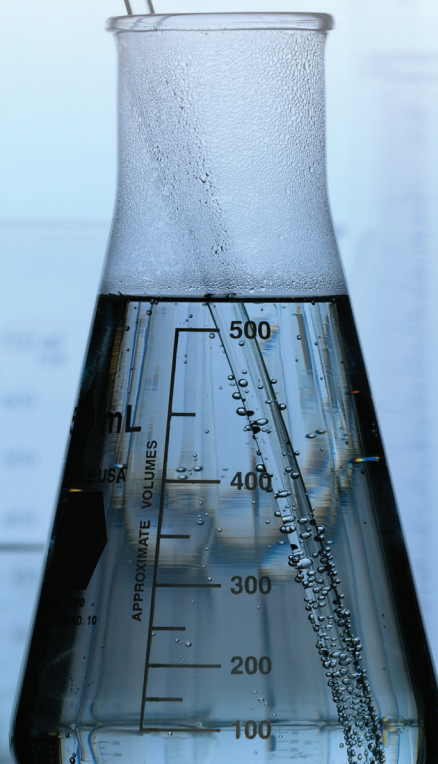

# Performance Glass: How to Select

## Laminated Glass

Laminated Hurricane Impact Resistant Glass is comprised of two sheets of glass bonded together with a protective interlayer. Laminated glass is the primary hurricane barrier used in impact resistant windows. Laminated glass also eliminates 99% of UV rays, reduces noise transmission, provides enhanced security protection for your home, and reduces the air conditioning and heating portion of your energy bill.

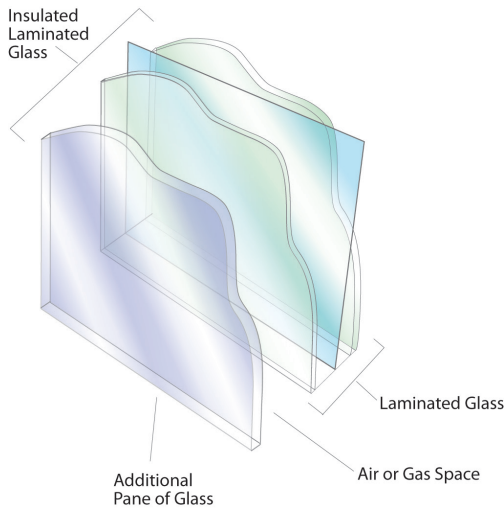

## Insulated Laminated Glass

Insulated Laminated Glass adds an extra single pane of glass to the laminated glass unit with a hermetically sealed air space (or gas filled space) in between. The air or gas filled space serves as an insulator between the temperature difference that exists between the inside and the outside. Although it is more useful in colder climates, it does improve the performance of LoE coatings and in some cases architects or local building departments are requiring its use.

## Tinted Glass

CGI offers a variety of glass tints. Tinted glass is likely the most cost effective solution combining cost reductions with energy efficiency. Tinted glass absorbs incoming solar radiation through the glass thereby reducing the heat and light transfer into a room. Gray and bronze tinted windows—the most common—reduce the penetration of both light and heat into buildings in equal amounts. Blue and green tinted windows offer greater penetration of visible light and slightly reduced heat transfer compared with other colors of tinted glass. Clear glass is also available, although without special coatings or tints, heat transfer is not minimized.

## High Performance LoE Coatings

LoE Coatings are applied to the internal glass surface to separate heat energy (long wave) and light energy (short wave). The heat energy (long wave) is reflected back to the heat source and the short wave can pass through the coating. CGI offers high performance coatings on its insulated laminated products. We also offer a high performance coating on our laminated products with a special interlayer, rather than the standard PVB interlayer. LoE coatings also exhibit certain color characteristics depending on viewing angles, reflected light and time of day.

## With all of these options of tints, LoE and Insulated Glass, how do I decide?

In warm tropical climates if you are cost conscious, avoid insulated glass if not required by codes. Suggest tinted glass or clear glass with LoE. If you want the best energy performance, consider insulated laminated glass with a LoE coating. Also, discuss with your dealer to ensure that you are in compliance with building code requirements. Selecting the appropriate impact resistant glass make-up is an important part of your window and door selection.

## Pick a glass tint from our wide selection

We offer a variety of tinted glass options. Generally we do not suggest combining glass tints with LoE coatings.\*



\*Glass tint colors shown may not be accurate representations.

+LoE coatings exhibit certain color characteristics depending on viewing angles, reflected light and time of day. For example, Cardinal LoE 366 exhibits a greenish hue. When Clear glass is coupled with a LoE 366 coating, during certain times of the day the reflected color can appear green from the outside. This LoE 366 coating offers an excellent combination of thermal performance, visible light transmittance, and value.

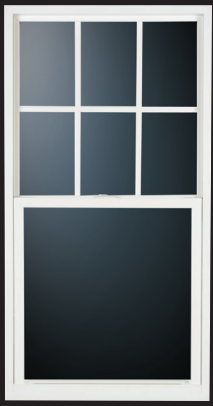

Single Hung



Casement



French Door



Horizontal Rolling



Project Out



Sliding Glass Door



Fixed and Designer Fixed

### The closer you look, the better Targa looks

### Super-View Screen Mesh



Nesting handle



Double applied contoured muntins



Flange frame

\*Competitors 5/8"



Clean weld lines



Our Super-View see-through screen material provides strong construction and clearer, unobstructed views. Our screens are constructed using a sturdy extruded frame design.



## Choose from a number of beautiful designer configurations

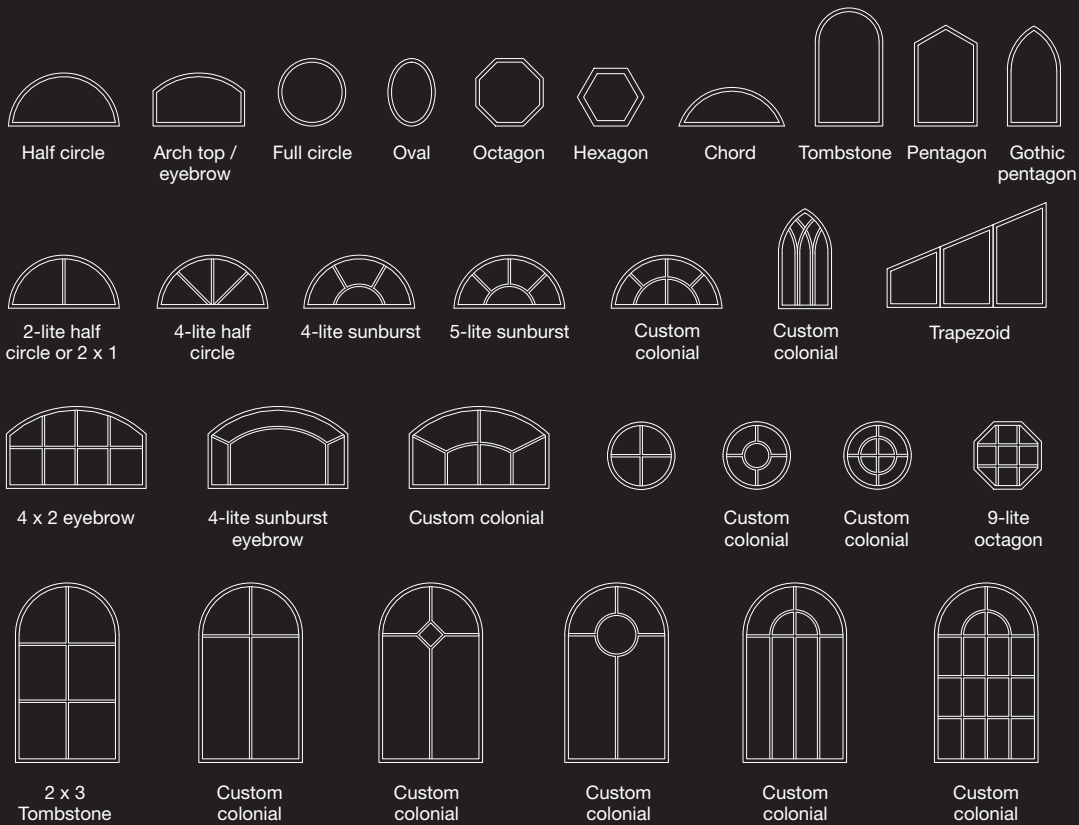

## Targa Products Offer Many Customizable Choices

### Frame Color

- White
- Two Tone - Painted Bronze Exterior / White Interior

### Glass Types

- Laminated
- Insulated Laminated

### Glass Tints

- Clear
- Gray
- Dark Gray (Turtle code)
- Bronze
- Solexia Green
- White Interlayer
- Mist (Pattern 62)
- Rain

### Glass Coatings

- Energy Efficient LoE options

### Single Hung

- Lift Assist Constant Force Balance System
- Extruded screen frame with Super-View screen mesh
- Capture-lock sash system

### Horizontal Rolling Window

- Two and three panel configurations OX, XO, XO
- Concealed installation fasteners
- Extruded screen frame with Super-View screen mesh
- Capture-lock sash system

### Casement/Project Out

- Stainless steel operator with nesting crank handle
- Stainless steel operator track
- Multipoint locking system with single locking handle
- Extruded screen frame with Super-View screen mesh

### Mullion Covers

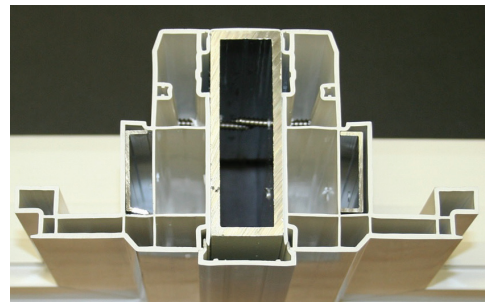

Interior mullion cover practically flush when installed with our 1 x 3 mullion.

# Targa Single Hung Window 7100

Concealed balances, capture-lock sash system and recessed tilt latches for unobstructed views.



## Available Finishes:

- White & Two Tone-Painted Bronze Exterior / White Interior

## Standard Glass Colors:

- Clear, Gray, Dark Gray (Turtle Code), Bronze, Solexia Green, White Interlayer, Mist (Pattern 62), Rain

## Glass Types:

- 7/16" Laminated
- 1" Insulated Laminated

## Glass Coatings:

- Energy efficient LoE options

## Standard Hardware:

- Snap lock
- Sweep locks (over 60 PSF)

## Standard Features:

- 1/2" Flange frame
- 3 1/4" frame depth
- Aluminum reinforced jamb
- Sloped sill
- Capture-lock sash system
- Lift Assist Constant Force Balance System
- Snap-on glazing beads
- Strong structural glazing
- No installation fasteners required in head or sill
- Aluminum reinforced sash
- Extruded screen frame with Super-View screen mesh

## Optional Items:

- Available in Oriel/Proview configurations
- Flange, fin & equal leg frame options
- Internal grills between glass

## Double Applied Exterior Muntin:



Contoured

## Glass Types:



Laminated Glass



Insulated Laminated Glass

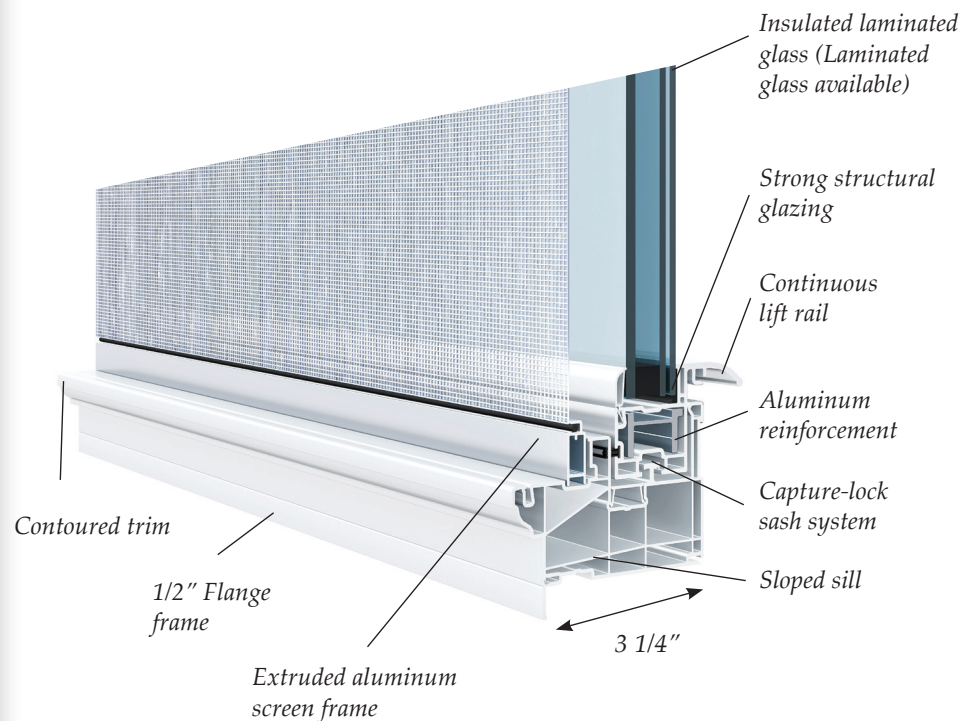

No installation fasteners required in head or sill.

### Commodity Sizes (In inches)

Width	Height	Width	Height	Width	Height	Width	Height
19 1/8	26	26 1/2	26	37	26	53 1/8	26
19 1/8	38 3/8	26 1/2	38 3/8	37	38 3/8	53 1/8	38 3/8
19 1/8	50 5/8	26 1/2	50 5/8	37	50 5/8	53 1/8	50 5/8
19 1/8	63	26 1/2	63	37	63	53 1/8	63 e
19 1/8	76	26 1/2	76	37	76 e	53 1/8	76 e

\* Sizes shown are for flange frame. Subtract 1" for equal leg frame  
 e = Meets clear opening egress requirement at 5.7 sq. ft.

### Modular Sizes (In inches)

Width	Height	Width	Height	Width	Height	Width	Height	Width	Height
24	26	32	26	40	26	44	26	48	26
24	38 3/8	32	38 3/8	40	38 3/8	44	38 3/8	48	38 3/8
24	50 5/8	32	50 5/8	40	50 5/8	44	50 5/8	48	50 5/8
24	63	32	63	40	63 e	44	63 e	48	63 e
24	76	32	76	40	76 e	44	76 e	48	76 e

\* Sizes shown are for flange frame. Subtract 1" for equal leg frame  
 e = Meets clear opening egress requirement at 5.7 sq. ft.

### Performance Results

Maximum Water Resistance		9 PSF
Small and Large Missile	54" x 77" (Ann/Ann) 54" x 77" (HS/HS)	+60 PSF /-60 PSF +70 PSF /-75 PSF
Forced Entry Test (ASTM F588)		Passed

\* Based on flange frame size

### Energy Values

Laminated		U Factor	SHGC	VT
7/16"	Clear LoE 366	0.81	0.27	0.46
7/16"	Gray	0.81	0.44	0.38
7/16"	Clear	0.81	0.56	0.67
Insulated Laminated				
1"	Clear LoE 366	0.28	0.21	0.48
1"	Clear LoE 270	0.29	0.28	0.52

# Targa Horizontal Rolling Window 7200

Super smooth rolling action available in up to 111" x 63" in a 3 panel configuration.



## Available Finishes:

- White & Two Tone-Painted Bronze Exterior / White Interior

## Standard Glass Colors:

- Clear, Gray, Dark Gray (Turtle Code), Bronze, Solexia Green, White Interlayer, Mist (Pattern 62), Rain

## Glass Types:

- 7/16" Laminated
- 1" Insulated Laminated

## Glass Coatings:

- Energy efficient LoE options

## Standard Hardware:

- Snap lock
- Sweep locks (over 60 PSF)

## Standard Features:

- Two & three panel configurations OX,XO,XOX
- Equal lites or 1/4-1/2-1/4 configurations
- 1/2" Flange frame
- 3 1/4" frame depth
- Snap-on glazing beads
- Strong structural glazing
- Concealed installation fasteners
- Aluminum reinforced sash
- Extruded screen frame with Super-View screen mesh
- Capture-lock sash system

## Optional Items:

- Flange, fin & equal leg frame options
- Internal grills between glass

## Double Applied Exterior Muntin:

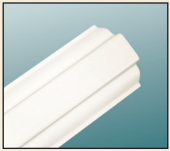

Contoured

## Glass Types:

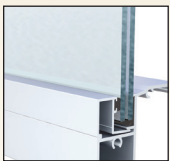

Laminated Glass

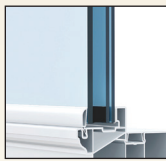

Insulated Laminated Glass

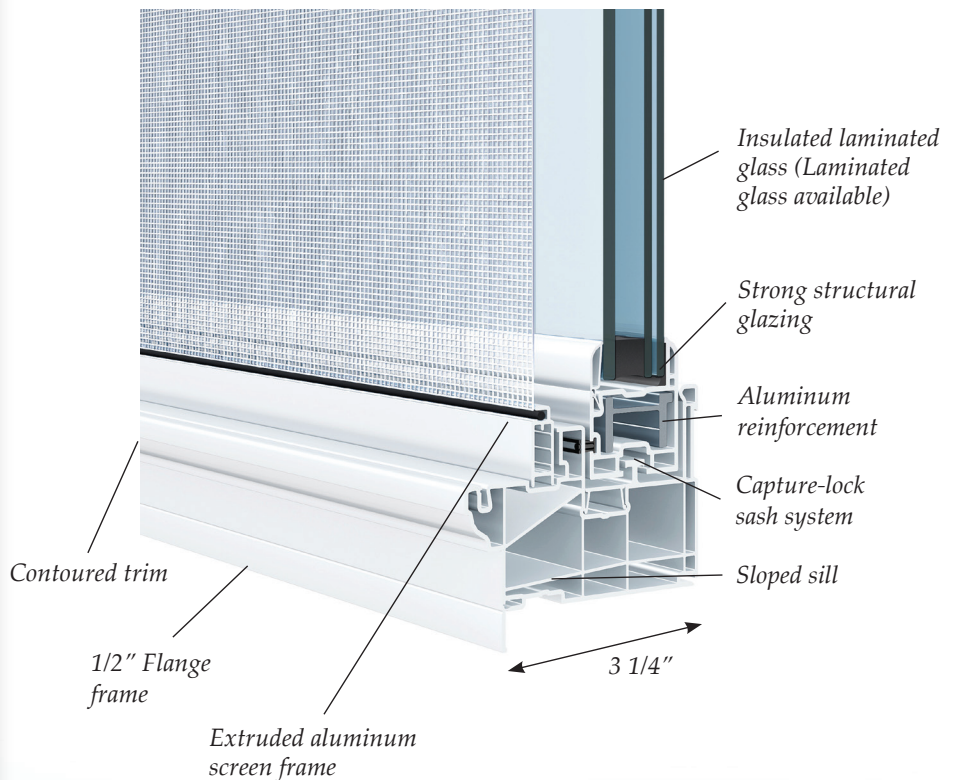

Commodity Sizes XO or OX (In inches)						Commodity Sizes XOx (In inches)							
Width	Height	Width	Height	Width	Height	Width	Height	Width	Height	Width	Height	Width	Height
26 1/2	26	37	26	53 1/8	26	53 1/8	26	74	26	106 3/8	26	111	26
26 1/2	38 3/8	37	38 3/8	53 1/8	38 3/8	53 1/8	38 3/8	74	38 3/8	106 3/8	38 3/8 e	111	38 3/8 e
26 1/2	50 5/8	37	50 5/8	53 1/8	50 5/8 e	53 1/8	50 5/8 e	74	50 5/8 e	106 3/8	50 5/8 e	111	50 5/8 e
26 1/2	63	37	63	53 1/8	63 e	53 1/8	63 e	74	63 e	106 3/8	63 e	111	63 e

\* Sizes shown are for flange frame. Subtract 1" for equal leg frame  
e = Meets clear opening egress requirement at 5.7 sq. ft.

Modular Sizes XO or OX (In inches)													
Width	Height	Width	Height	Width	Height	Width	Height	Width	Height	Width	Height	Width	Height
36	26	48	26	54	26	60	26	66	26	72	26	74	26
36	38 3/8	48	38 3/8	54	38 3/8	60	38 3/8	66	38 3/8 e	72	38 3/8 e	74	38 3/8 e
36	50 5/8	48	50 5/8	54	50 5/8 e	60	50 5/8 e	66	50 5/8 e	72	50 5/8 e	74	50 5/8 e
36	54	48	54	54	54 e	60	54 e	66	54 e	72	54 e	74	54 e
36	63	48	63	54	63 e	60	63 e	66	63 e	72	63 e	74	63 e

\* Sizes shown are for flange frame. Subtract 1" for equal leg frame  
e = Meets clear opening egress requirement at 5.7 sq. ft.

Modular Sizes XOx (In inches)											
Width	Height	Width	Height	Width	Height	Width	Height	Width	Height	Width	Height
48	26	60	26	72	26	84	26	96	26	108	26
48	38 3/8	60	38 3/8	72	38 3/8	84	38 3/8	96	38 3/8 e	108	38 3/8 e
48	50 5/8	60	50 5/8	72	50 5/8	84	50 5/8 e	96	50 5/8 e	108	50 5/8 e
48	54	60	54	72	54	84	54 e	96	54 e	108	54 e
48	63	60	63	72	63	84	63 e	96	63 e	108	63 e

\* Sizes shown are for flange frame. Subtract 1" for equal leg frame  
e = Meets clear opening egress requirement at 5.7 sq. ft.

Performance Results		
Maximum Water Resistance		9 PSF
Small and Large Missile	2 panel 74 3/4" x 63" (Ann/Ann) 3 panel 111" x 63" (Ann/Ann) 2 panel 74 3/4" x 63" (HS/HS) 3 panel 111" x 63" (HS/HS)	+60 PSF /-60 PSF +60 PSF /-60 PSF +70 PSF /-75 PSF +70 PSF /-75 PSF
Forced Entry Test (ASTM F588)		Passed

\* Based on flange frame size

Energy Values				
Laminated		U Factor	SHGC	VT
7/16"	Clear LoE 366	0.81	0.27	0.45
7/16"	Gray	0.81	0.43	0.37
7/16"	Clear	0.81	0.55	0.65
Insulated Laminated				
1"	Clear LoE 366	0.28	0.21	0.47
1"	Clear LoE 270	0.28	0.27	0.51

**Available Finishes:**

- White & Two Tone-Painted Bronze Exterior / White Interior

**Standard Glass Colors:**

- Clear, Gray, Dark Gray (Turtle Code), Bronze, Solexia Green, White Interlayer, Mist (Pattern 62), Rain

**Glass Types:**

- 7/16" Laminated
- 1" Insulated Laminated

**Glass Coatings:**

- Energy efficient LoE options

**Standard Hardware:**

- Stainless steel arm operator with nesting crank handle
- Stainless steel operator track
- Hinges with washability features
- Pair of stainless steel concealed hinges
- Multipoint lock system with single locking handle
- Stainless steel keepers
- Aluminum super-snobber blocks
- Small operator on units less than 24"
- Large operator on units 24" or more

**Standard Features:**

- Snap-on glazing beads
- Triple weatherstripping
- 1/2" flange frame
- 3 1/4" frame depth
- Strong structural glazing
- Aluminum reinforced frames and sash
- Extruded screen frame with Super-View screen mesh

**Optional Items:**

- Limit opening devices
- Flange, fin and equal leg frame options
- Internal grills between glass

**Double Applied Exterior Muntin:**



Contoured

**Glass Types:**



Laminated Glass

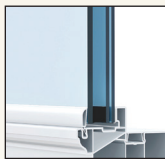

Insulated Laminated Glass

# Targa Casement Window 7300

Multipoint locks, nesting handle, and a stainless steel package including operators and hinges.

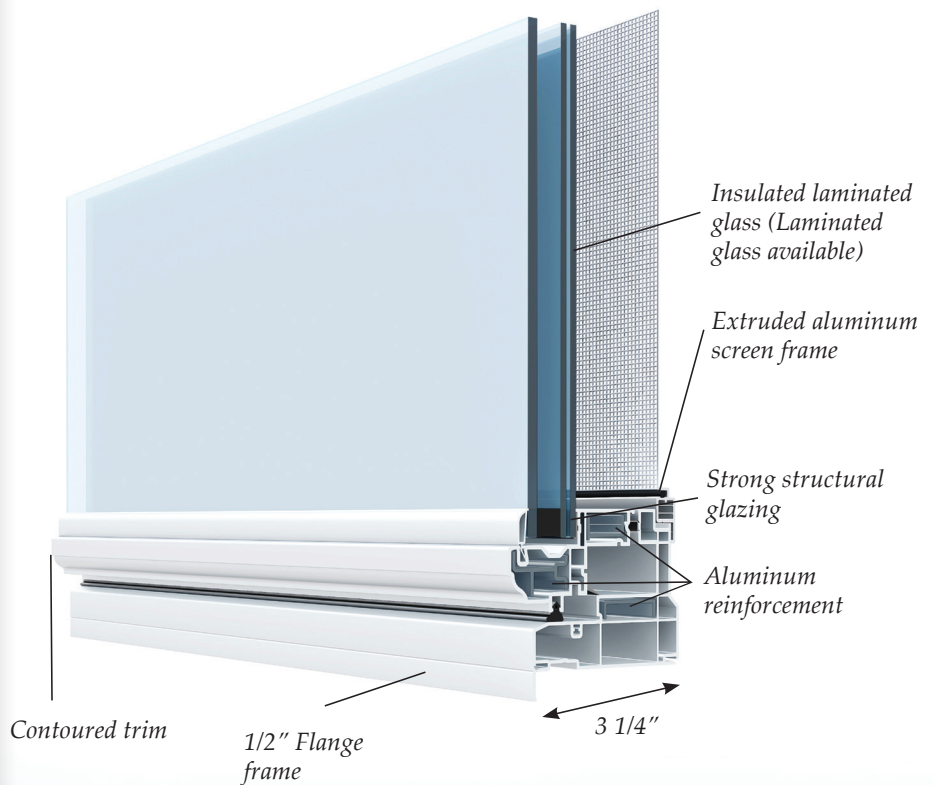

### Commodity Sizes (In inches)

Width	Height	Width	Height	Width	Height
19 1/8	26	26 1/2	26	37	26
19 1/8	38 3/8	26 1/2	38 3/8	37	38 3/8
19 1/8	50 5/8	26 1/2	50 5/8	37	50 5/8 e
19 1/8	63	26 1/2	63	37	63 e
19 1/8	76	26 1/2	76	37	76 e

\* Sizes shown are for flange frame. Subtract 1" for equal leg frame  
e = Meets clear opening egress requirement at 5.7 sq. ft.

### Modular Sizes (In inches)

Width	Height	Width	Height	Width	Height
24	26	28	26	32	26
24	38	28	38	32	38
24	51	28	51	32	51
24	55	28	55	32	55
24	63	28	63	32	63
24	76	28	76	32	76

\* Sizes shown are for flange frame. Subtract 1" for equal leg frame

### Performance Results

Maximum Water Resistance		9 PSF
Small and Large Missile	37" x 76" (Ann/Ann) 37" x 76" (HS/HS)	+60 PSF /-60 PSF +70 PSF /-70 SF
Forced Entry Test (ASTM F588)		Passed

\* Based on flange frame size

### Energy Values

Laminated		U Factor	SHGC	VT
7/16"	Clear LoE 366	0.74	0.25	0.41
7/16"	Gray	0.74	0.39	0.34
7/16"	Clear	0.74	0.51	0.60
Insulated Laminated				
1"	Clear LoE 366	0.29	0.19	0.43
1"	Clear LoE 270	0.29	0.25	0.46

**Available Finishes:**

- White & Two Tone-Painted Bronze Exterior / White Interior

**Standard Glass Colors:**

- Clear, Gray, Dark Gray (Turtle Code), Bronze, Solexia Green, White Interlayer, Mist (Pattern 62), Rain

**Glass Types:**

- 7/16" Laminated
- 1" Insulated Laminated

**Glass Coatings:**

- Energy efficient LoE options

**Standard Hardware:**

- Stainless steel arm operator with nesting crank handle
- Stainless steel operator track
- Pair of stainless steel concealed hinges
- Multipoint lock system with single locking handle
- Stainless steel keepers
- Aluminum super-snubber blocks
- Small operator on units less than 22"
- Large operator on units 22" or more

**Standard Features:**

- Snap-on glazing beads
- Triple weatherstripping
- 1/2" flange frame
- 3 1/4" frame depth
- Strong structural glazing
- Aluminum reinforced frames and sash
- Extruded screen frame with Super-View screen mesh

**Optional Items:**

- Flange, fin and equal leg frame options
- Internal grills between glass

**Double Applied Exterior Muntin:**



Contoured

**Glass Types:**



Laminated Glass



Insulated Laminated Glass

# Targa Project Out Window 7400

Multipoint locks, nesting handle, and a stainless steel package including operators and hinges.

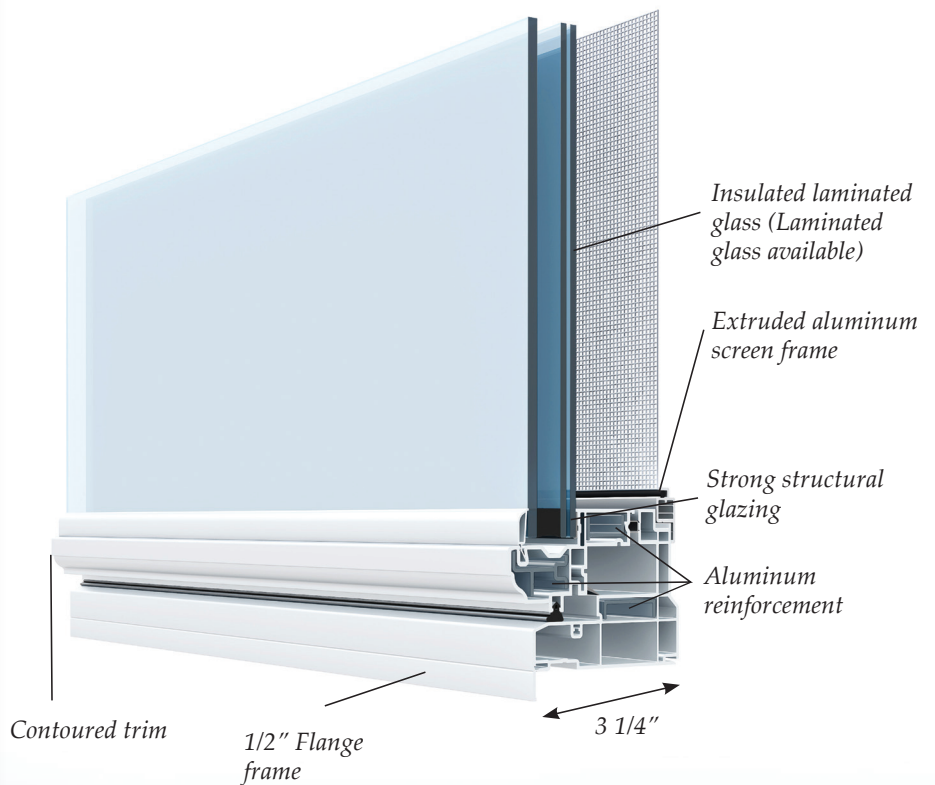



### Commodity Sizes (In inches)

Width	Height	Width	Height	Width	Height	Width	Height
19 1/8	17	26 1/2	17	37	17	53 1/8	17
19 1/8	26	26 1/2	26	37	26	53 1/8	26
19 1/8	38 3/8	26 1/2	38 3/8	37	38 3/8	53 1/8	38 3/8
19 1/8	50 5/8	26 1/2	50 5/8	37	50 5/8		

\* Sizes shown are for flange frame. Subtract 1" for equal leg frame

### Modular Sizes (In inches)

WxH	WxH	WxH	WxH	WxH	WxH	WxH	WxH	WxH
20x24	24x24	28x24	30x24	32x24	36x24	40x24	42x24	48x24
20x30	24x30	28x30	30x30	32x30	36x30	40x30	42x30	48x30
20x36	24x36	28x36	30x36	32x36	36x36	40x36	42x36	48x36
20x42	24x42	28x42	30x42	32x42	36x42	40x42	42x42	48x42
20x48	24x48	28x48	30x48	32x48	36x48			

\* Sizes shown are for flange frame. Subtract 1" for equal leg frame

### Performance Results

Maximum Water Resistance		9 PSF
Small and Large Missile	53 1/8" x 39" (Ann/Ann) 53 1/8" x 39" (HS/HS)	+60 PSF /-60 PSF +75 PSF /-75 PSF
Forced Entry Test (ASTM F588)		Passed

\* Based on flange frame size

### Energy Values

Laminated		U Factor	SHGC	VT
7/16"	Clear LoE 366	0.78	0.25	0.41
7/16"	Gray	0.77	0.39	0.34
7/16"	Clear	0.77	0.51	0.60
Insulated Laminated				
1"	Clear LoE 366	0.29	0.19	0.43
1"	Clear LoE 270	0.30	0.25	0.46

**Available Finishes:**

- White & Two Tone-Painted Bronze Exterior / White Interior

**Standard Glass Colors:**

- Clear, Gray, Dark Gray (Turtle Code), Bronze, Solexia Green, White Interlayer, Mist (Pattern 62), Rain

**Glass Types:**

- 7/16" Laminated
- 1" Insulated Laminated

**Glass Coatings:**

- Energy efficient LoE options

**Standard Hardware:**

- Snap-on glazing beads
- 1/2" Flange frame
- 3 1/4" frame depth
- Strong structural glazing
- Concealed installation fasteners

**Designer Fixed Windows:**

- Half circle
- Arch top/eyebrow
- Full circle
- Octagon
- Hexagon
- Chord
- Tombstone
- Trapezoid
- Pentagon
- Gothic pentagon

**Optional Items:**

- Flange, fin & equal leg frame options
- Internal grills between glass

**Double Applied Exterior Muntin:**



Contoured

**Glass Types:**

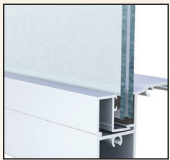

Laminated Glass

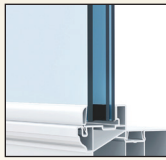

Insulated Laminated Glass

# Targa Fixed Window 7500

Concealed installation fasteners available up to 32 square feet.

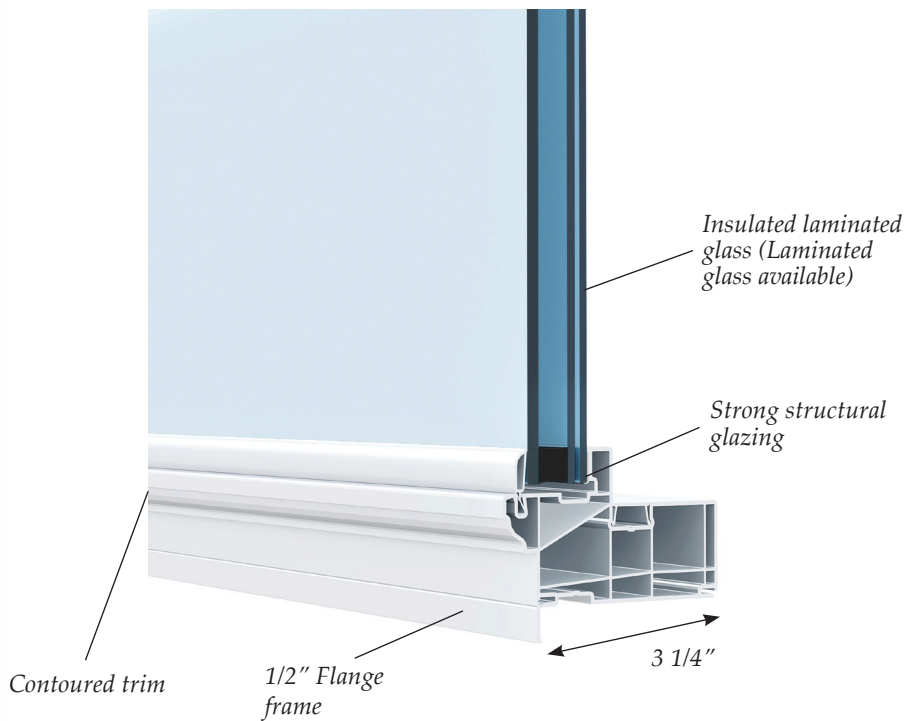

- Maximum area is 32 sq ft

Height x Width = Area

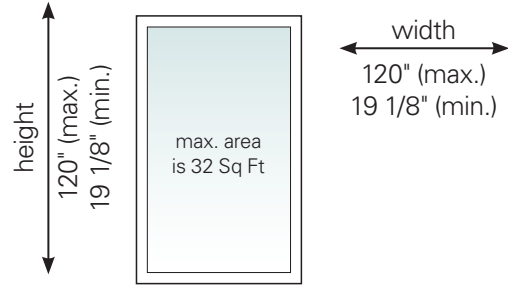

### Performance Results

Maximum Water Resistance		12 PSF
Small and Large Missile	48" x 63" (Ann/Ann) 48" x 63" (SGP only) 48" x 96" (SGP only)	+50 PSF / -50 PSF +80 PSF / -80 PSF +75 PSF / -75 PSF
Forced Entry Test (ASTM F588)		Passed

\* Based on flange frame size

### Energy Values

Laminated		U Factor	SHGC	VT
7/16"	Clear LoE 366	0.83	0.30	0.50
7/16"	Gray	0.82	0.47	0.41
7/16"	Clear	0.82	0.61	0.73
Insulated Laminated		U Factor	SHGC	VT
1"	Clear LoE 366	0.27	0.23	0.52
1"	Clear LoE 270	0.27	0.30	0.56

**Available Finishes:**

- White, Two-Tone Co-Extruded Capstock Bronze Exterior/ White Interior

**Standard Glass Colors:**

- Clear, Dark Gray (Turtle Code), Bronze, Solexia Green, White Interlayer, Mist (Pattern 62), Rain

**Glass Type:**

- 1 1/16" Insulated Laminated Glass

**Glass Coatings:**

- Energy efficient LoE options

**Standard Hardware:**

- Interior lock and handle
- Color matched to frame
- Tandem steel roller assembly
- Dual-point mortise lock

**Standard features:**

- Equal leg/box frame
- Sill risers and track inserts are clear anodized

**Optional Items:**

- Various sill risers
- Multi-panel by-pass and pocket styles
- Standard or box screen
- Tandem stainless steel or nylon roller assembly
- Dual point mortise lock with key lock
- Recessed lock
- Secondary Lock
- Internal grills between glass
- Oil-rubbed bronze hardware

**Standard Hardware:**

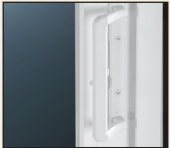

**Glass Types:**



Insulated Laminated Glass

# Targa Sliding Glass Door 7650

Panels up to 4' x 10' or 5' x 8' in multiple track and pocket door configurations, with dual point locking mechanism and hidden installation and assembly screws.

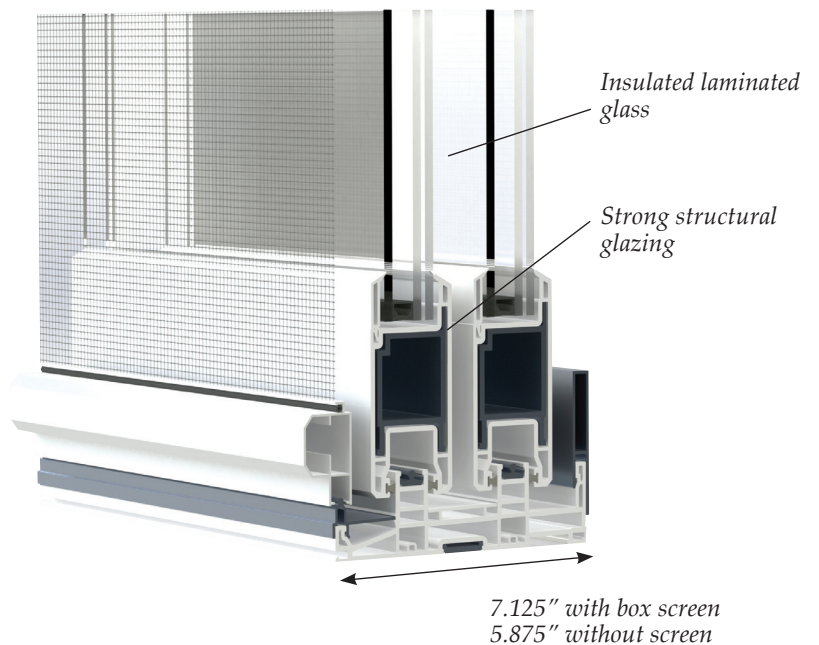

## Targa Sliding Glass Door 7650

**Targa 6'8",7',8',9' and 10' Sliding Glass Door Sizes** (80", 84", 96", 108", and 120" frame heights)

2 Track Configuration	Call Width	Frame Width	3 Track Configuration	Call Width	Frame Width	4 Track Configuration	Call Width	Frame Width	
OX,XO, XX-R, XX	4-0	48"	XXX,XXO XXX-R,OXX	7-6	87 3/16"	XXXO, OXXX, XXXX, XXXXR	10-0	114 3/8"	
	5-0	60"		9-0	105 3/16"		12-0	138 3/8"	
	6-0	72"		12-0	141 3/16"		16-0	186 3/8"	
	8-0	96"		15-0	177 3/16"		20-0	234 3/8"	
	10-0	120"							
OXO,OXO-R	9-0	109 13/16"	OXXXXO, XXXXXX	15-0	173 3/8"	OXXXXXXO, XXXXXXX	20-0	227 11/16"	
	12-0	145 13/16"		18-0	209 3/8"		24-0	275 11/16"	
	15-0	181 13/16"		24-0	281 3/8"		32-0	371 11/16"	
OXXO,XXXX	10-0	119"		30-0	353 3/8"		40-0	467 11/16"	
	12-0	143"							
	16-0	191"							
	20-0	239"							

Pocket configurations available

Performance Results		
Maximum Water Resistance	With 3 1/2" waterbar adaptor	9 PSF
	With 4 1/16" waterbar adaptor	12 PSF
	With 4 5/8" waterbar adaptor	15 PSF
Large Missile	4' x 10' Panel (HS/HS)	+60 PSF /-65 PSF
	5' x 8' Panel (HS/HS)	+80 PSF /-80 PSF
	4' x 8' Panel (ANN/HS)	+60 PSF /-60 PSF
Forced Entry Test (ASTMF 842)		Passed

DP varies based on riser height. 3 1/2" riser= +60 PSF, 4 1/16" riser = +80 PSF

Energy Values (NFRC Certified)				
Insulated Laminated		U Factor	SHGC	VT
1 1/16"	Clear LoE 366	0.32	0.19	0.42
1 1/16"	Clear LoE 270	0.32	0.25	0.45

**Available Finishes:**

- White, Two-Tone Co-Extruded Capstock Bronze Exterior/ White Interior

**Standard Glass Colors:**

- Clear, Dark Gray (Turtle Code), Bronze, Solexia Green, White Interlayer, Mist (Pattern 62), Rain

**Glass Type:**

- 1 3/16" Insulated laminated

**Glass Coatings:**

- Energy efficient LoE options

**Standard Hardware:**

- Handle with escutcheon plate (Satin Nickel)

**Standard features:**

- Outswing
- Single or Double Door
- Stainless steel hinges
- Equal leg/box frame
- Installation screw covers
- Anchor plates
- Drip Cap
- 1 3/8" clear anodized threshold and cover

**Optional Items:**

- Configurable sidelites and transoms
- 5/8" add-on front flange
- Internal grills between glass
- Oil-rubbed bronze hardware

**Standard Hardware** (all hardware also available in satin nickel) :



Active 100-Style Handle  
(Inactive 100-Style Handle Also Available)



Active 800-Style Handle



InActive 800-Style Handle

**Glass Types:**



Insulated Laminated Glass

# Targa French Door 7700

Multipoint locking system with stainless steel hinges. Available with sidelites attached with clipless mullions and transoms in four different frame styles. 4 9/16" frame depth allows for easy retrofit install.

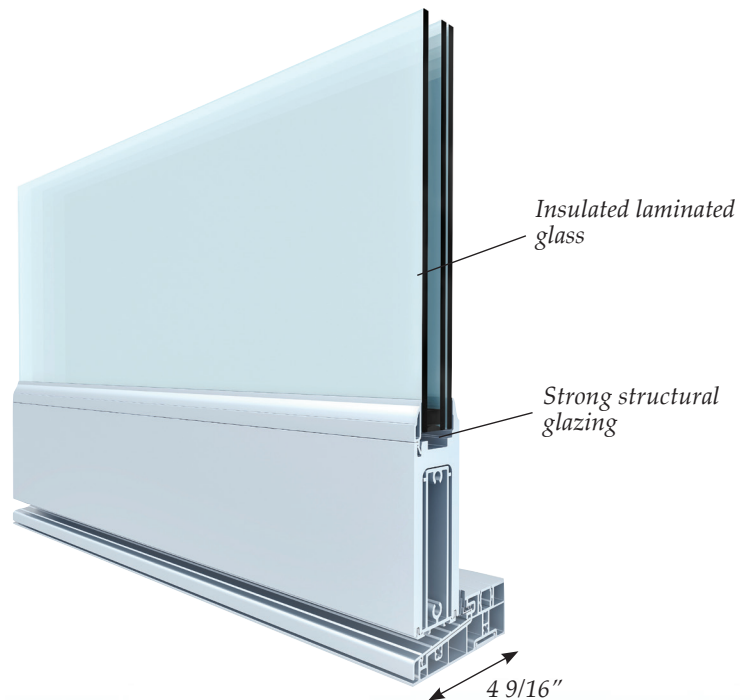

**Targa French Door 7700**  
**Door Sizes (In inches)**

Single						Double					
6' 8"			8' 0"			6' 8"			8' 0"		
Code Size	Width	Height	Code Size	Width	Height	Code Size	Width	Height	Code Size	Width	Height
2068	25 3/4	80	2080	25 3/4	96	4068	48	80	4080	48	96
2668	31 3/4	80	2680	31 3/4	96	5068	60	80	5080	60	96
2868	33 3/4	80	2880	33 3/4	96	5468	64	80	5480	64	96
3068	37 3/4	80	3080	37 3/4	96	6068	72	80	6080	72	96
3168	39	80	3180	39	96	6468	76	80	6480	76	96

\* Sizes shown are masonry opening, no buck.  
 Also available in 7' heights.

**Free-Standing Sidelites (In inches)**

	Minimum Size	Maximum Size
Narrow frame sidelite and transom	12" x 20" or 20" x 12"	40" x 111" or 111" x 40"
Full head and sill sidelite and transom	12" x 27" or 20" x 19"	40" x 111" or 111" x 40"
Full jamb sidelite and transom	27" x 12" or 19" x 20"	40" x 111" or 111" x 40"
Full frame sidelite and transom	27" x 19" or 19" x 27"	40" x 111" or 111" x 40"

**Performance Results**

Maximum Water Resistance		10.5 PSF
Large Missile	3' x 8' Panel (Ann/Ann Glass)	+70 PSF /-70 PSF
Forced Entry Test (AAMA 1304-02)		Passed

**Energy Values (NFRC Certified)**

Insulated Laminated		U Factor	SHGC	VT
1 3/16"	Clear LoE 366	0.30	0.17	0.36
1 3/16"	Clear LoE 270	0.30	0.22	0.39



**Impact Resistant  
Windows & Doors**  
WE'RE STRONGER™

